

Embedded WiFi/ISM/BT/Zigbee Antenna
2.4 GHz, 2.0x1.2mm

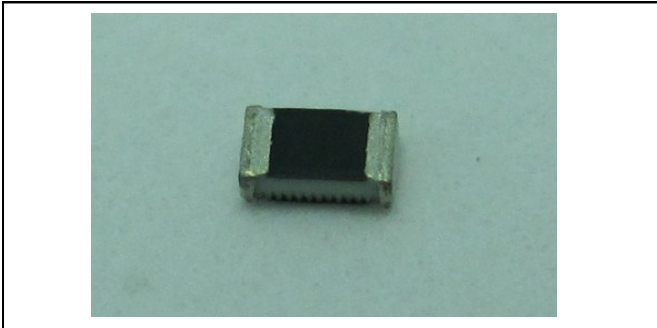

KEY BENEFITS

Ethertronics' series of Ceramic Antennas deliver on the key needs of device designers for higher functionality and performance in smaller/thinner designs. These innovative antennas provide compelling advantages for 2.4GHz enabled cell phones, media players and other mobile devices.

DESIGN ADVANTAGES

Best in Class Performance

- Minimal ground clearance and component “keep out” area.
- High selectivity eliminates the need for additional filters and frees up board space.

Quicker Time-to-Market

- Standard part means fewer design changes.
- Simple implementation.
- Single part works for various PCB sizes and layouts.

RoHS Compliant

- Ethertronics' antennas comply with the European RoHS Directive 2002/95/EC.

More information is available on our Website at www.ethertronics.com/resources/.

END USER ADVANTAGES

Superior Range

- Greater antenna efficiency means longer range and a better end user experience.

Exceptional Coverage

- Better coverage delivers more reliable wireless connections for mobile phones, laptops, stereo headsets, cars media players, audio systems and more.

SERVICE AND SUPPORT

Extensive RF Experience

- Our antennas are supported by extensive documentation, and when needed, by the expertise of RF engineers who have integrated hundreds of antenna designs into wireless devices.

Global Operations & Design Support

- Ethertronics' global operations encompass an integrated network of design centers that provide local customer support.

PRODUCT: Embedded 2.4GHz Antenna - P/N 1001312

Ethertronics' Embedded BT Ceramic Antenna Specifications
 Ethertronics produces a wide variety of standard and custom antennas to meet user needs.
 Below are the typical performances.

Electrical Specifications

Typical Characteristics

All values are defined, Pi matching circuit will be required, Test board size = 110x55mm ground plane.

	Specifications
Frequency Band	2.400GHz ~ 2.485GHz
VSWR	Less than 3
Polarization	Linear
Peak Gain	1.72 dBi Typ.
Peak Efficiency	72.3% Typ
Impedance	50Ω Typ.

Mechanical Specifications

Size	2.00x1.20x0.55mm
Mounting	Surface Mount

L	W	H	A
2.0±0.3	1.2±0.3	.55±0.2	0.4±0.25

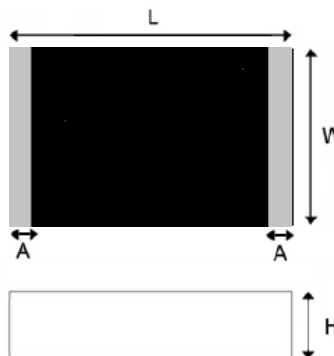

VSWR

Mark	Frequency	VSWR
1	2400 MHz	1.80
2	2442 MHz	1.53
3	2483 MHz	2.28

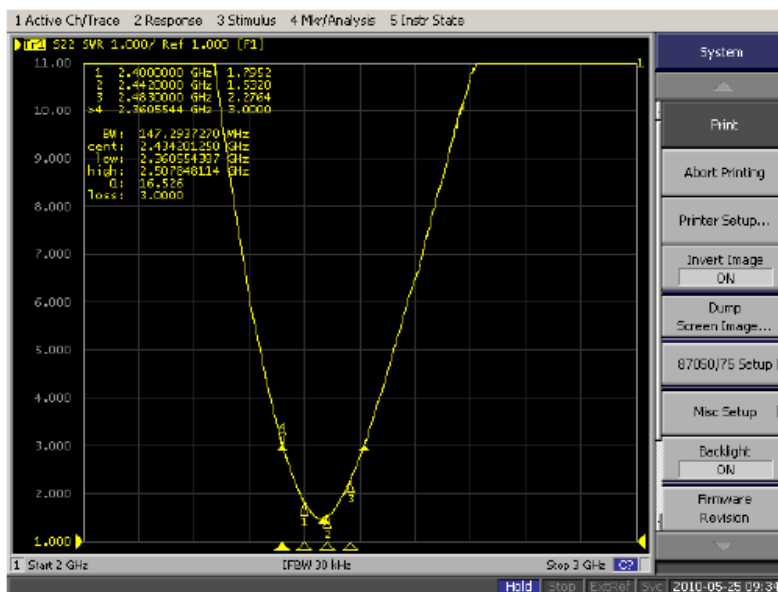

Recommended PCB Layout (Unit = mm)

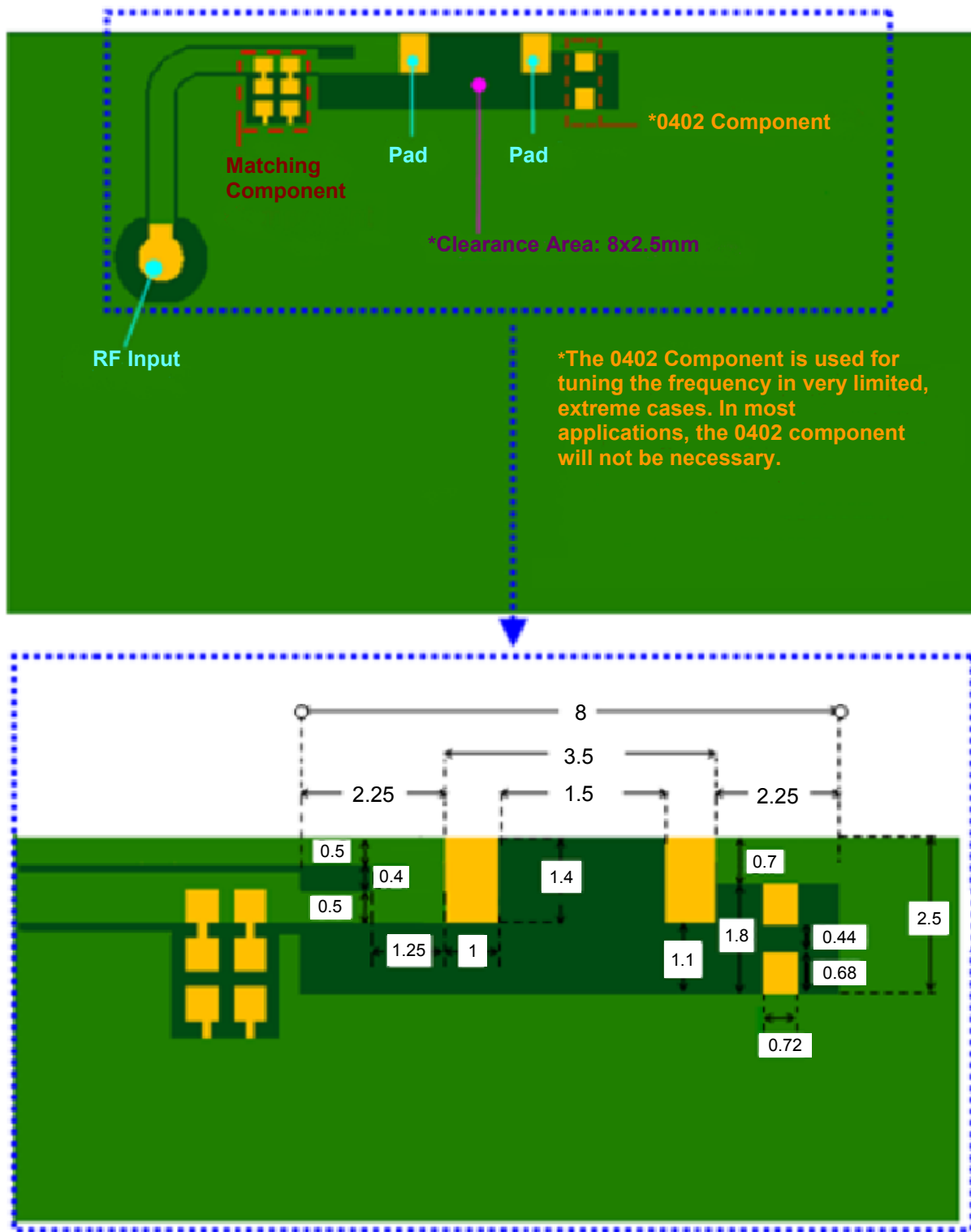

*Clearance area 8mm x 2.5mm: All metallization should be removed from all PCB layers.

PRODUCT: Embedded 2.4GHz Antenna - P/N 1001312

2D Gain Patterns (2442 MHz)

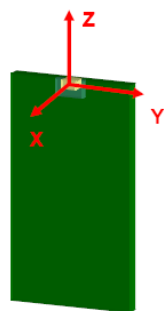

- E-theta
- E-phi
- E-total

X-Y Plane

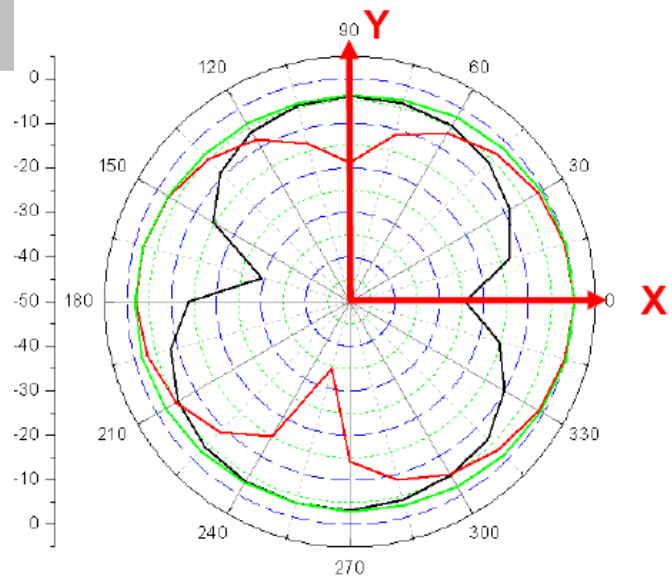

Y-Z Plane

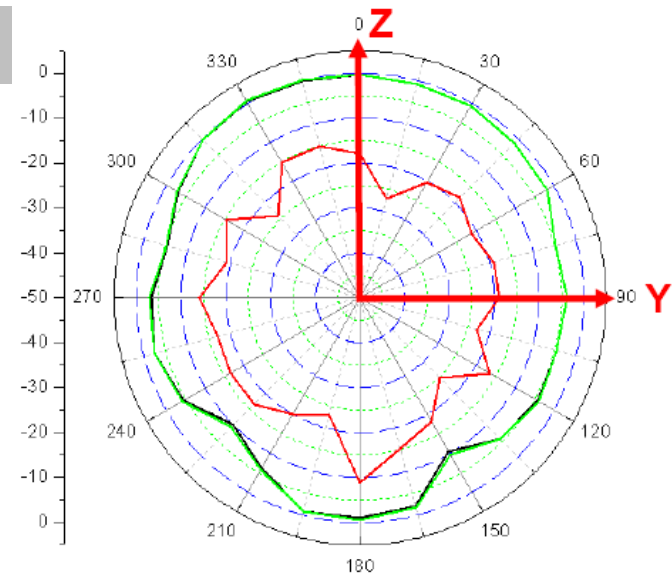

X-Z Plane

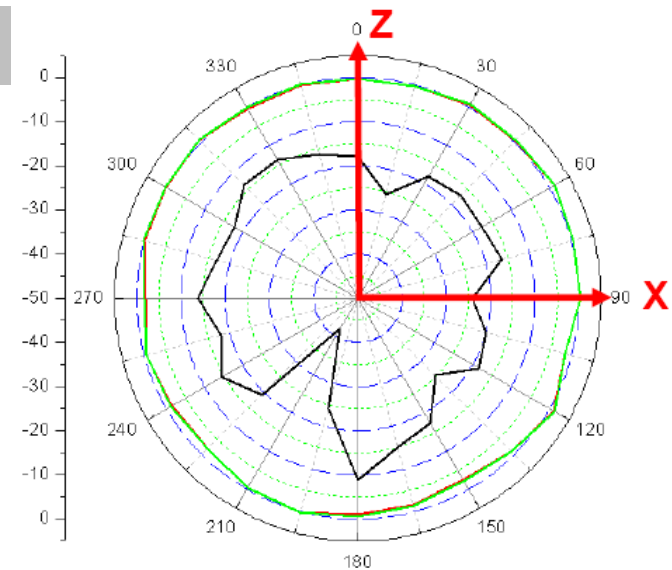

PRODUCT: Embedded 2.4GHz Antenna - P/N 1001312

Tape & Reel Specifications

Quantity/Reel = 5,000

Unit = mm

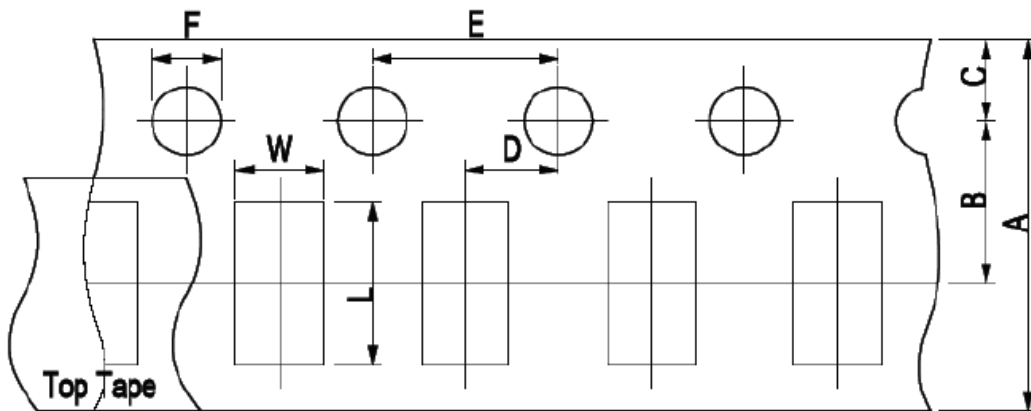

A	B	C	D	E	F	L	W
8.00±0.30	3.5±0.05	1.75±0.10	2.00±0.05	4.00±0.10	1.50±0.10	2.30±0.10	1.55±0.10

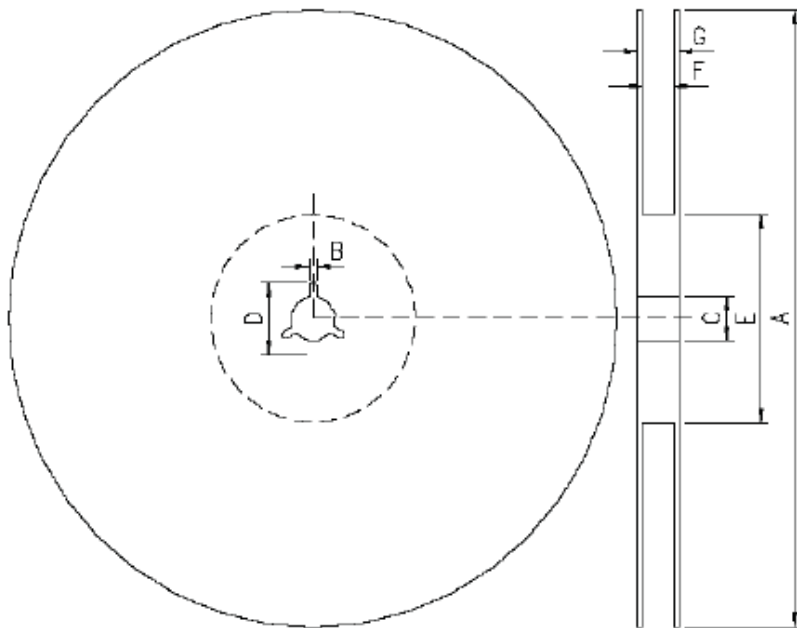

Symbol	Spec.
A	178.0±2.0
B	2.0±0.5
C	13.0±0.5
D	21.0±0.8
E	62.0±1.5
F	9.0±0.5
G	13.0±1.0

Reliability Testing

Item	Condition	Specification
Thermal Shock	<ol style="list-style-type: none">1. 30±3 minutes at -40°C±5°C2. Convert to +105°C (5 minutes)3. 30±3 minutes at +105°C±5°C4. Convert to -40°C (5 minutes)5. Total: 100 continuous cycles	No apparent damage. Fulfills the electrical spec after test.
Humidity Resistance	<ol style="list-style-type: none">1. Humidity: 85% R.H.2. Temperature: 85±5°C3. Time: 1,000 hours	No apparent damage. Fulfills the electrical spec after test.
High Temperature Resistance	<ol style="list-style-type: none">1. Temperature: 150°C±5°C2. Time: 1,000 hours	No apparent damage. Fulfills the electrical spec after test.
Low Temperature Resistance	<ol style="list-style-type: none">1. Temperature: -40°C±5°C2. Time: 1,000 hours	No apparent damage. Fulfills the electrical spec after test.
Soldering Heat Resistance	<ol style="list-style-type: none">1. Solder bath temperature: 260±5°C2. Bathing time: 10±1 seconds	No apparent damage.
Solderability	The dipped surface of the terminal shall be at least 95% covered with solder after being dipped in a solder bath of 245±5°C for 3±1 seconds	No apparent damage.

Storage Conditions

Warehouse Temperature Range:

The temperature should be within 0~30°C and humidity should be less than 60% RH.
The product should be used within 1 year from the time of delivery

On Board Temperature Range:

The temperature should be within -40~85°C and humidity should be less than 85% RH.

Operating Temperature Range

Operating temperature range: -40°C to +105°C

Recommended Reflow Soldering

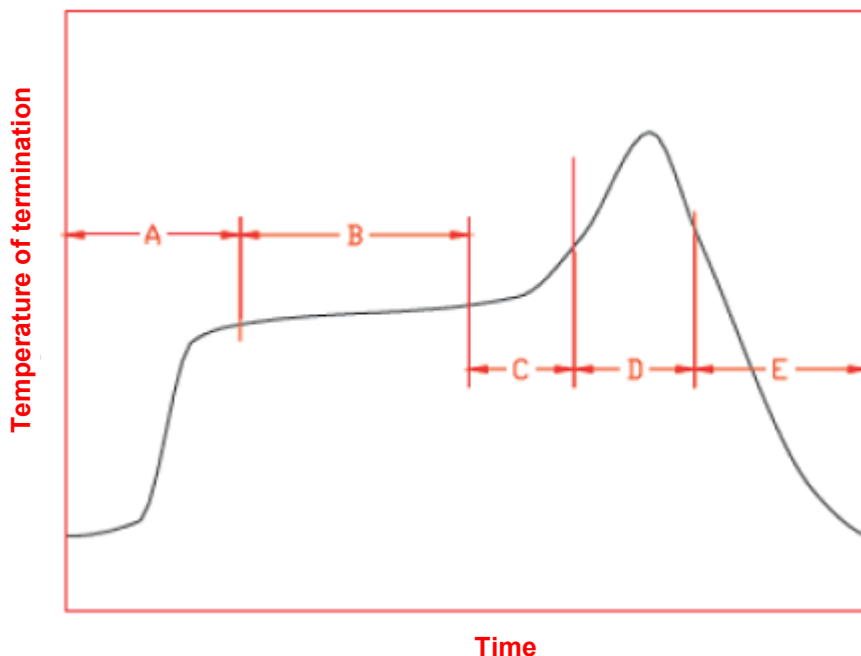

A	1 st Rising Temperature	The normal to preheating temperature	30s to 60s
B	Preheating	140°C to 160°C	60s to 120s
C	2 nd Rising Temperature	Preheating to 200°C	20s to 40s
D	Main Heating	if 220°C	50s~60s
		if 230°C	40s~50s
		if 240°C	30s~40s
		if 250°C	20s~40s
		if 260°C	20s~40s
E	Regular Cooling	200°C to 100°C	1°C /s ~ 4°C /s
*reference: J-STD-020C			

Soldering Gun Procedure

Note the following when using a solder gun to replace the antenna

1. The tip temperature must be less than 350°C for the period within 3 seconds when using a soldering gun under 30W.
2. The soldering gun tip shall not touch this part directly.

Soldering Volume

Note that excess of soldering volume will easily crack the body of this product.