

Getting started with the X-NUCLEO-IDW04A1 Wi-Fi expansion board based on SPWF04SA module for STM32 Nucleo

Introduction

This document provides detailed hardware requirements and board connections for the X-NUCLEO-IDW04A1 Wi-Fi expansion board based on SPWF04SA Serial-to-Wi-Fi modules, to allow expansion of the STM32 Nucleo boards. The SPWF04SA module is FCC (FCC ID: S9NSPWFS04), IC certified (IC: 8976C-SPWFS04) and CE certified and includes an STM32 MCU, a low-power 2.4 GHz IEEE 802.11 b/g/n transceiver with integrated power amplifier and power management, and an SMD antenna.

The X-NUCLEO-IDW04A1 can be plugged onto STM32 Nucleo boards via the Arduino™ UNO R3 connector (ST morpho connector compatibility is also available). Therefore, different expansion boards can easily be stacked on the X-NUCLEO-IDW04A1 board, allowing evaluation of Wi-Fi connectivity together with several devices in different application scenarios.

The expansion board features:

- Onboard SPWF04SA module (order code: SPWF04SA) based on the STM32 MCU and a low power Wi-Fi b/g/n transceiver SoC
- USART or SPI configurable connections
- Jumpers to drive the SPWF04SA module RESET and low power capabilities
- Push button to explore Wi-Fi protected setup feature
- Connectors for SPWF04SA module GPIOs (user software dependent)

Figure 1: X-NUCLEO-IDW04A1 expansion board

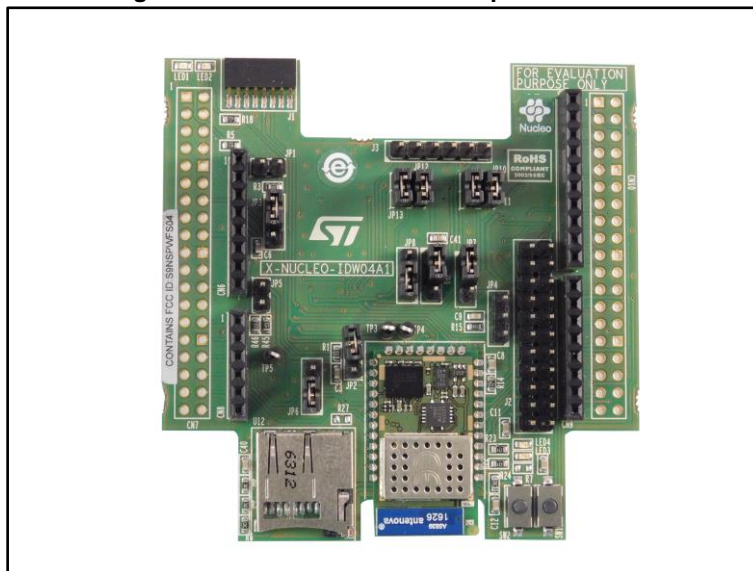

Contents

1 Getting started..... 5

 1.1 Hardware requirements..... 5

 1.2 System requirements 5

 1.3 Board setup..... 6

2 Hardware description..... 7

 2.1 X-NUCLEO-IDW04A1 expansion board for STM32 Nucleo..... 7

 2.2 STM32 Nucleo connections 10

 2.3 UART/SPI interface and GPIO connection options 10

 2.4 Current measurement 12

 2.5 X-NUCLEO-IDW04A1 component placement details..... 13

3 Component description 15

 3.1 SPWF04SA module 15

 3.2 User push-buttons and LEDs 15

 3.3 User interface configuration 15

4 Radio certification 17

 4.1 Formal notices required by the U.S. federal communications
commission (FCC) 17

 4.2 Formal notices required by industry Canada (IC)..... 17

 4.3 Formal notices required by the ETSI (CE) 17

5 Bill of materials..... 18

6 Schematic diagrams..... 21

7 Revision history 22



List of tables

Table 1: UART/SPI 0 Ω resistor configuration	6
Table 2: STM32 Nucleo board/X-NUCLEO-IDW04A1 interconnection (ST morpho connector: CN7)	8
Table 3: STM32 Nucleo board/X-NUCLEO-IDW04A1 interconnection (ST morpho connector: CN7): hardware	8
Table 4: STM32 Nucleo board/X-NUCLEO-IDW04A1 interconnection (ST morpho connector: CN10)	8
Table 5: STM32 Nucleo board/X-NUCLEO-IDW04A1 interconnection (Arduino UNO R3 connector: CN6 - power)	9
Table 6: STM32 Nucleo board/X-NUCLEO-IDW04A1 interconnection (Arduino UNO R3 connector: CN8 - analog)	9
Table 7: STM32 Nucleo board/X-NUCLEO-IDW04A1 interconnection (Arduino UNO R3 connector: CN5 - digital)	10
Table 8: STM32 Nucleo board/X-NUCLEO-IDW04A1 interconnection (Arduino UNO R3 connector: CN9 - digital)	10
Table 9: SPWF04SA module UART interface with STM32 Nucleo board	11
Table 10: SPWF04SA module SPI interface with STM32 Nucleo board	11
Table 11: SPWF04SA module details	15
Table 12: Push-buttons and LED functions	15
Table 13: X-NUCLEO-IDW04A1 board user mode configuration settings	16
Table 14: X-NUCLEO-IDW04A1 bill of materials	18
Table 15: Document revision history	22

List of figures

Figure 1: X-NUCLEO-IDW04A1 expansion board.....	1
Figure 2: X-NUCLEO-IDW04A1 expansion board connected to an STM32 Nucleo board.....	5
Figure 3: UART default jumper configuration	6
Figure 4: SPI jumper configuration	6
Figure 5: SPWF04SA module to STM32 Nucleo connector scheme	7
Figure 6: X-NUCLEO-IDW04A1 expansion board component placement details: top	13
Figure 7: X-NUCLEO-IDW04A1 expansion board component placement details: bottom	14
Figure 8: X-NUCLEO-IDW04A1 circuit schematic.....	21

1 Getting started

1.1 Hardware requirements

The X-NUCLEO-IDW04A1 is an expansion board for the STM32 Nucleo boards. To function correctly, it must be plugged on a STM32 Nucleo board through the Arduino™ UNO R3 connectors as shown in the figure below. Information on STM32 Nucleo is available at <http://www.st.com/stm32nucleo>.

Figure 2: X-NUCLEO-IDW04A1 expansion board connected to an STM32 Nucleo board

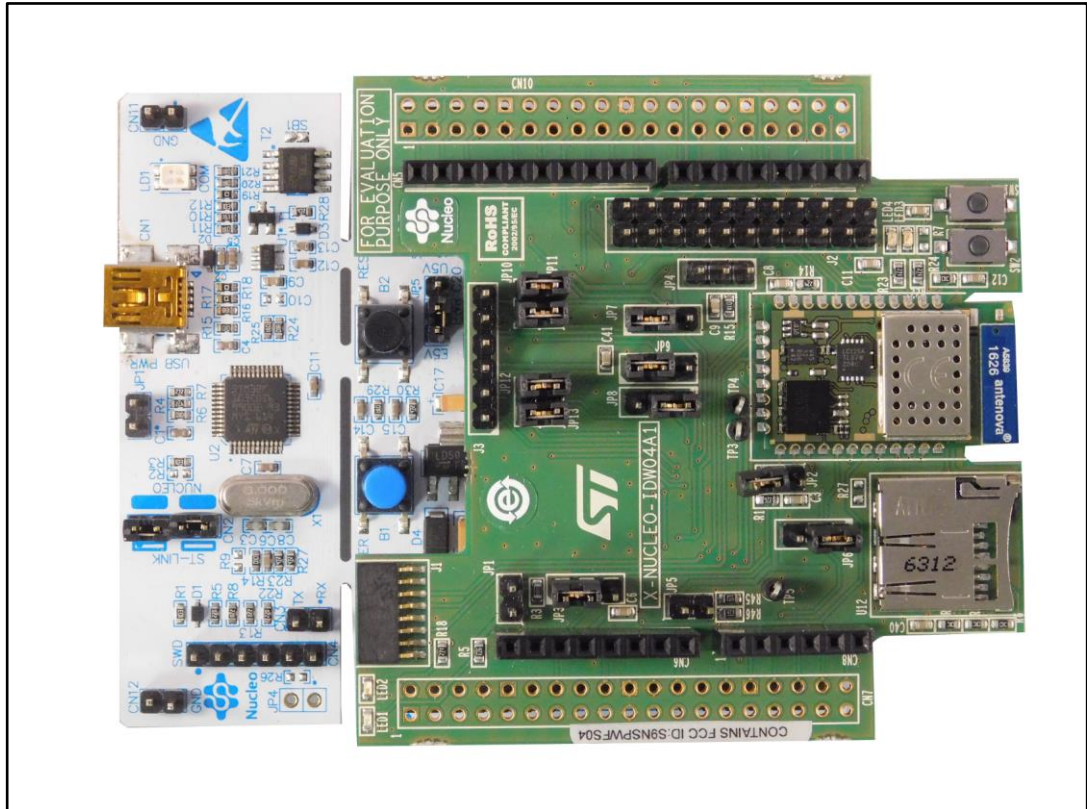

The X-NUCLEO-IDW04A1 can be connected to any STM32 Nucleo board, even though complete testing was performed on the NUCLEO-L476RG, NUCLEO-F401RE and NUCLEO-F411RE development boards.

1.2 System requirements

Using the STM32 Nucleo boards with the X-NUCLEO-IDW04A1 expansion board requires:

- a Windows PC (7, 8 and above) to install the firmware package;
- a USB type A to Mini-B USB cable to connect the STM32 Nucleo board to the PC.

Installation of the board firmware package (order code: X-CUBE-WIFI1) and the Wi-Fi graphical user interface utility on the user PC requires:

- 128 MB of RAM
- 40 MB of hard disk space

The X-CUBE-WIFI1 firmware and relative documentation are available on www.st.com.

1.3 Board setup

To set up the board:

- 1 Ensure that a jumper on JP3 is connected (position 1-2); it sends the RESET signal to the SPWF04A1 module on the board.
- 2 Ensure that jumpers on JP6, JP7, JP8, JP9 are connected (position 1-2); they link UART module signals to STM32 Nucleo UART peripheral.
If the SPI interface is preferred, ensure that jumpers JP6, JP7, JP8, JP9 (position 2-3) are connected.
- 3 Ensure that jumpers on JP10, JP11, JP12, JP13 are connected (for position and configuration, refer to [Figure 3: "UART default jumper configuration"](#)) and MicroPython 0 Ω resistors are unsoldered.

These jumpers are needed to properly drive UART module signals to the STM32 Nucleo.

Figure 3: UART default jumper configuration

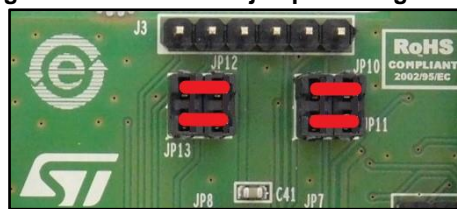

If the SPI interface is preferred, ensure that jumpers on JP10, JP11, JP12, JP13 are connected (for position and configuration, refer to [Figure 4: "SPI jumper configuration"](#)) and MicroPython 0 Ω resistors are unsoldered.

Figure 4: SPI jumper configuration

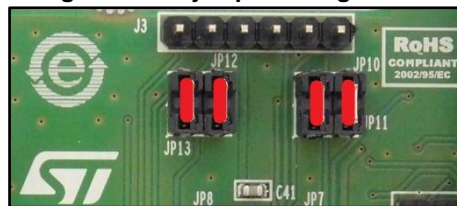

If the MicroPython feature is preferred, remove jumpers on JP10, JP11, JP12, JP13 (refer to the following table for a full 0 Ω resistor configuration).

Table 1: UART/SPI 0 Ω resistor configuration

Peripheral	R9	R11	R36	R42	R43	R44	R47	R48
UART	M	M	NM	NM	M	NM	NM	M
SPI	NM	NM	M	M	NM	M	M	NM

- 4 Plug the X-NUCLEO-IDW04A1 on the STM32 Nucleo board, as shown in [Figure 2: "X-NUCLEO-IDW04A1 expansion board connected to an STM32 Nucleo board"](#).
- 5 Power the STM32 Nucleo development board through the Mini-B USB cable.
- 6 Program the STM32 Nucleo development board using the sample firmware provided.
- 7 Reset the STM32 Nucleo development board MCU through the onboard Reset button.
- 8 The board setup is ready to evaluate Wi-Fi connectivity.

2 Hardware description

2.1 X-NUCLEO-IDW04A1 expansion board for STM32 Nucleo

The expansion board allows testing of the functionality of the SPWF04SA module, which embeds a low power Wi-Fi b/g/n transceiver SoC, an SMD antenna and an STM32 MCU.

Board functionality can be manipulated through the firmware packaged with the X-CUBE-WIFI1 software, which must be programmed on the STM32 Nucleo board microcontroller (refer to user manuals available on www.st.com for further information on STM32 Nucleo boards).

The SPWF04SA module and the STM32 Nucleo board are connected through connectors CN5, CN6, CN8 and CN9 (Figure 5: "SPWF04SA module to STM32 Nucleo connector scheme"). Moreover, considering that signals are also replicated on CN7 (Table 2: "STM32 Nucleo board/X-NUCLEO-IDW04A1 interconnection (ST morpho connector: CN7)") and CN10 (Table 4: "STM32 Nucleo board/X-NUCLEO-IDW04A1 interconnection (ST morpho connector: CN10)"), it is useful to show the indirect connection between STM32 Nucleo board and X-NUCLEO-IDW04A1 (Table 5: "STM32 Nucleo board/X-NUCLEO-IDW04A1 interconnection (Arduino UNO R3 connector: CN6 - power)", Table 6: "STM32 Nucleo board/X-NUCLEO-IDW04A1 interconnection (Arduino UNO R3 connector: CN8 - analog)", Table 7: "STM32 Nucleo board/X-NUCLEO-IDW04A1 interconnection (Arduino UNO R3 connector: CN5 - digital)" and Table 8: "STM32 Nucleo board/X-NUCLEO-IDW04A1 interconnection (Arduino UNO R3 connector: CN9 - digital)").

Figure 5: SPWF04SA module to STM32 Nucleo connector scheme

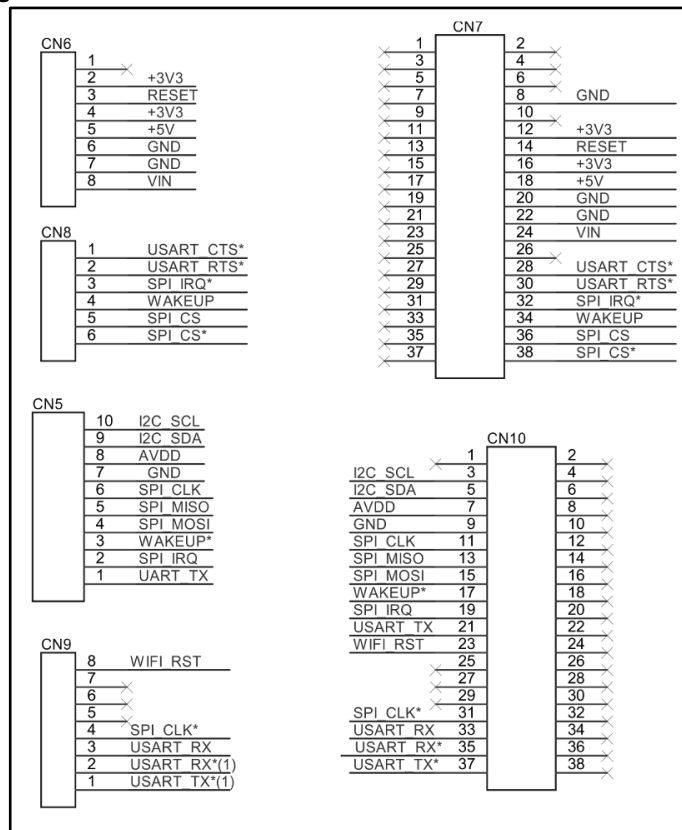

Table 2: STM32 Nucleo board/X-NUCLEO-IDW04A1 interconnection (ST morpho connector: CN7)

CN7 odd - UNUSED			CN7 even		
Pin	Name	MCU name	Fcn	MCU name	Pin
1					2
3					4
5					6
7				GND	8
9					10
11				+3V3	12
13				RESET	14
15				+3V3	16
17				+5 V	18
19				GND	20
21				GND	22
23				VIN	24

Table 3: STM32 Nucleo board/X-NUCLEO-IDW04A1 interconnection (ST morpho connector: CN7): hardware

CN7 odd			CN7 even		
25					26
27			USART_CTS ⁽¹⁾	PA0	28
29			USART_RTS ⁽¹⁾	PA1	30
31			SPI_IRQ ⁽¹⁾	PA4	32
33			WAKEUP	PB0	34
35			SPI_CS	PC1 (PB9 ⁽¹⁾)	36
37			SPI_CS ⁽¹⁾	PC0 (PB8 ⁽¹⁾)	38

Notes:⁽¹⁾Disabled by 0 Ω default configuration

Table 4: STM32 Nucleo board/X-NUCLEO-IDW04A1 interconnection (ST morpho connector: CN10)

CN10 odd			CN10 even-UNUSED		
Pin	MCU name	Fcn	Fcn	MCU name	Pin
1					2
3	PB8	I2C_SCL			4
5	PB9	I2C_SDA			6
7	AVDD				8
9	GND				10
11	PA5 (PB13 ⁽¹⁾)	SPI_CLK			12

CN10 odd			CN10 even-UNUSED		
13	PA6 (PB14 ⁽¹⁾)	SPI_MISO			14
15	PA7 (PB15 ⁽¹⁾)	SPI_MOSI			16
17	PB6	WAKEUP ⁽¹⁾			18
19	PC7	SPI_IRQ			20
21	PA9	USART_TX			22
23	PA8	WIFI_RST			24
25					26
27					28
29					30
31	PB3	SPI_CLK ⁽¹⁾			32
33	PA10	USART_RX			34
35	PA2	USART_RX ⁽¹⁾			36
37	PA3	USART_TX ⁽¹⁾			38

Notes:

⁽¹⁾Disabled by 0Ω default configuration

Table 5: STM32 Nucleo board/X-NUCLEO-IDW04A1 interconnection (Arduino UNO R3 connector: CN6 - power)

Signal name	NC	IOREF	RESET	+3V3	+5 V	GND 1	GND 2	VIN
Pin	1	2	3	4	5	6	7	8
MCU name		+3V3	RESET	+3V3	+5 V	GND	GND	VIN
Fcn								

Table 6: STM32 Nucleo board/X-NUCLEO-IDW04A1 interconnection (Arduino UNO R3 connector: CN8 - analog)

Signal name	A0	A1	A2	A3	A4	A5
Pin	1	2	3	4	5	6
MCU name	PA0	PA1	PA4	PB0	PC1 (PB9 ⁽¹⁾)	PC0 (PB8 ⁽¹⁾)
Fcn	USART_CTS ⁽¹⁾	USART_RTS ⁽¹⁾	SPI_IRQ ⁽¹⁾	WAKEUP	SPI_CS	SPI_CS ⁽¹⁾

Notes:

⁽¹⁾Disabled by 0 Ω default configuration

Table 7: STM32 Nucleo board/X-NUCLEO-IDW04A1 interconnection (Arduino UNO R3 connector: CN5 - digital)

Signal name	D15	D14	AREF	GND	D13	D12	D11	D10	D9	D8
Pin	10	9	8	7	6	5	4	3	2	1
MCU name	PB8	PB9			PA5 (PB13 ⁽¹⁾)	PA6 (PB14 ⁽¹⁾)	PA7 (PB15 ⁽¹⁾)	PB6	PC7	PA9
Fcn	I2C_SCL	I2C_SDA	AVD D	GND	SPI_CLK	SPI_MISO	SPI_MOSI	WAKE UP ⁽¹⁾	SPI_I RQ	UA RT_ TX

Notes:

⁽¹⁾Disabled by 0 Ω default configuration

Table 8: STM32 Nucleo board/X-NUCLEO-IDW04A1 interconnection (Arduino UNO R3 connector: CN9 - digital)

Signal name	D7	D6	D5	D4	D3	D2	D1	D0
Pin	8	7	6	5	4	3	2	1
MCU name	PA8				PB3	PA10	PA2	PA3
Fcn	WIFI_RST				SPI_CLK ⁽¹⁾	UART_RX	USART_RX ⁽¹⁾⁽²⁾	USART_TX ⁽¹⁾⁽²⁾

Notes:

⁽¹⁾Disabled by 0 Ω default configuration

⁽²⁾used by STM32 Nucleo board and connected to ST-LINK

2.2 STM32 Nucleo connections

The X-NUCLEO-IDW04A1 expansion board is designed to be plugged directly on the STM32 Nucleo board connectors. The X-NUCLEO-IDW04A1 is configured by default to be compatible with as many STM32 Nucleo boards as possible. It may also be configured, via jumper or resistor placement, to use different I/O configurations to match specific customer targets.

2.3 UART/SPI interface and GPIO connection options

The connection between the SPWF04SA and the STM32 Nucleo board is made via a four-wire UART (with hardware flow control; refer to [Table 9: "SPWF04SA module UART interface with STM32 Nucleo board"](#)) or a five-wire SPI (see [Table 10: "SPWF04SA module SPI interface with STM32 Nucleo board"](#)), and some GPIOs.

A multiple connection arrangement offers the maximum modularity.

The alternative pins could be useful in case of conflicts with additional STM32 Nucleo expansion boards.

Table 9: SPWF04SA module UART interface with STM32 Nucleo board

SPWF04SA Pin/Signal	STM32 pin	Placement
6/TXD	PA9	CN10 – pin 21 CN5 – Pin 1 To use this connection: mount R31 and remove R39 (Default)
	PA3 ⁽¹⁾	CN10 – pin 37 CN9 – Pin 1 To use this connection: mount R39 and remove R31
8/RXD	PA10	CN10 – pin 33 CN9 – Pin 3 To use this connection: mount R37 and remove R38 (Default)
	PA2 ⁽¹⁾	CN10 – pin 35 CN9 – Pin 2 To use this connection: mount R38 and remove R37
9/CTS	PA0	CN8 – pin 1 CN7 – pin 28 To use this optional connection: mount R8
10/RTS	PA1	CN8 – pin 2 CN7 – pin 30 To use this optional connection: mount R10

Notes:

⁽¹⁾Please refer to UM1724 for instructions on modifying the STM32 Nucleo board to use these pins.

Table 10: SPWF04SA module SPI interface with STM32 Nucleo board

SPWF04SA Pin/Signal	STM32 pin	Placement
6/MISO	PA6 (PB14 ⁽¹⁾)	CN10 – pin 13 CN5 – Pin 1
7/GPIO9	PC7	CN10 – pin 19 CN5 – Pin 2 To use this connection: mount R28 and remove R13 (Default)
	PA4	CN7 – pin 32 CN8 – Pin 3 To use this connection: mount R13 and remove R28
8/MOSI	PA7 (PB15 ⁽¹⁾)	CN10 – pin 15 CN5 – Pin 4

SPWF04SA Pin/Signal	STM32 pin	Placement
9/NSS	PC1 (PB9 ⁽¹⁾)	CN7 – pin 36 CN8 – Pin 5 To use this connection: mount R26 and remove R29 (Default)
	PC0 (PB8 ⁽¹⁾)	CN7 – pin 38 CN8 – Pin 6 To use this connection: mount R29 and remove R26
10/SCK	PA5 (PB13 ⁽¹⁾)	CN10 – pin 11 CN5 – Pin 6 To use this connection: mount R16 and remove R32 (Default)
	PB3	CN10 – pin 31 CN9 – Pin 4 To use this connection: mount R32 and remove R16

Notes:

⁽¹⁾Please refer to UM1724 for instructions on modifying the STM32 Nucleo board to use these pins.



To use the optional connections, you need to modify the firmware for the right allocation of STM32 Nucleo resources.

2.4 Current measurement

To monitor SPWF04SA module power consumption, remove R3 (0 Ω resistor) and, using jumper JP1 contacts as connectors, insert an ammeter probe between connector pins 1 and 2 and measure current absorption.

Since SPWF04SA power consumption is usually very low, accurate instrumentation able to take measurements in the order of a few μA may be required.

2.5 X-NUCLEO-IDW04A1 component placement details

Figure 6: X-NUCLEO-IDW04A1 expansion board component placement details: top

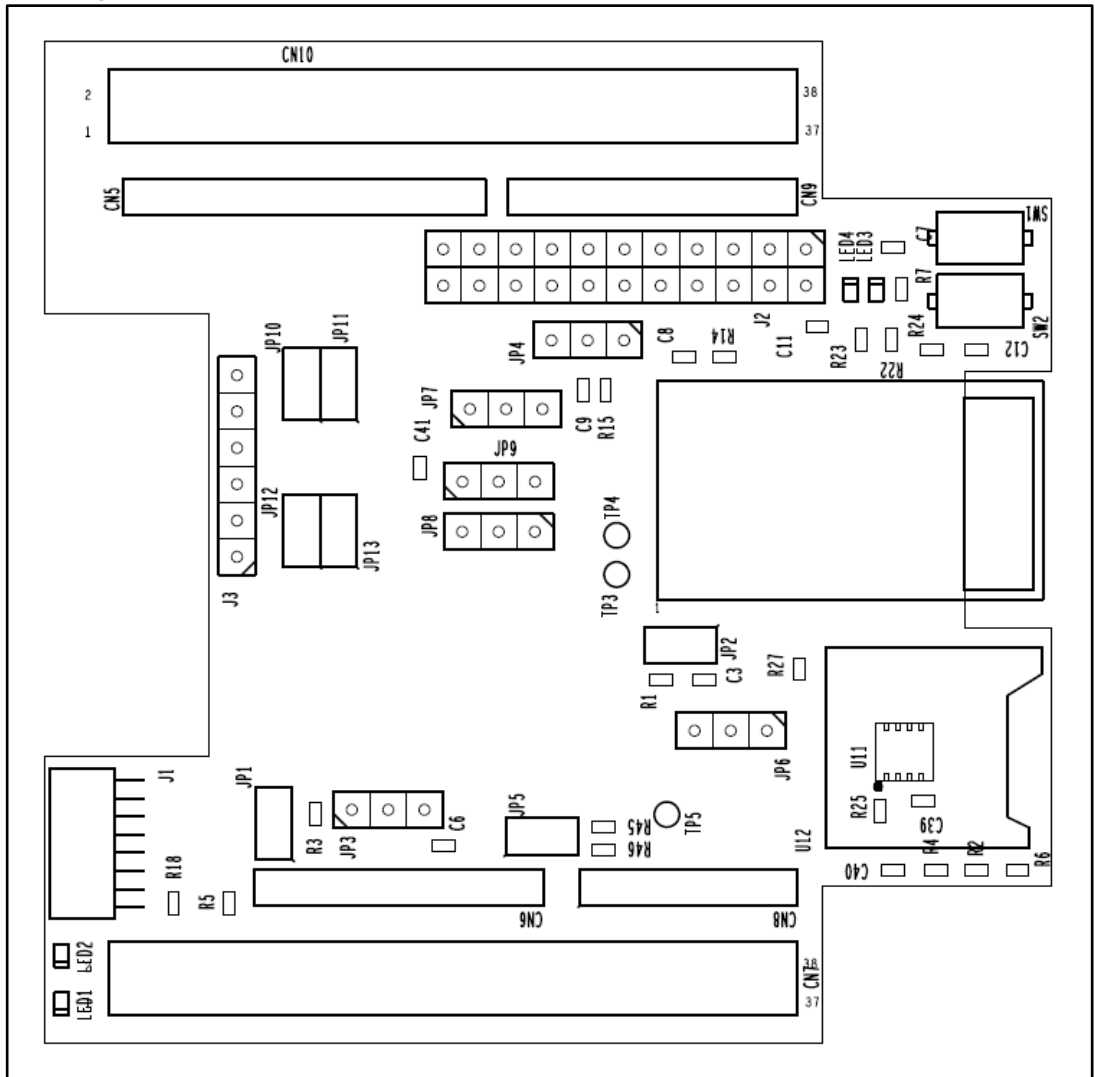
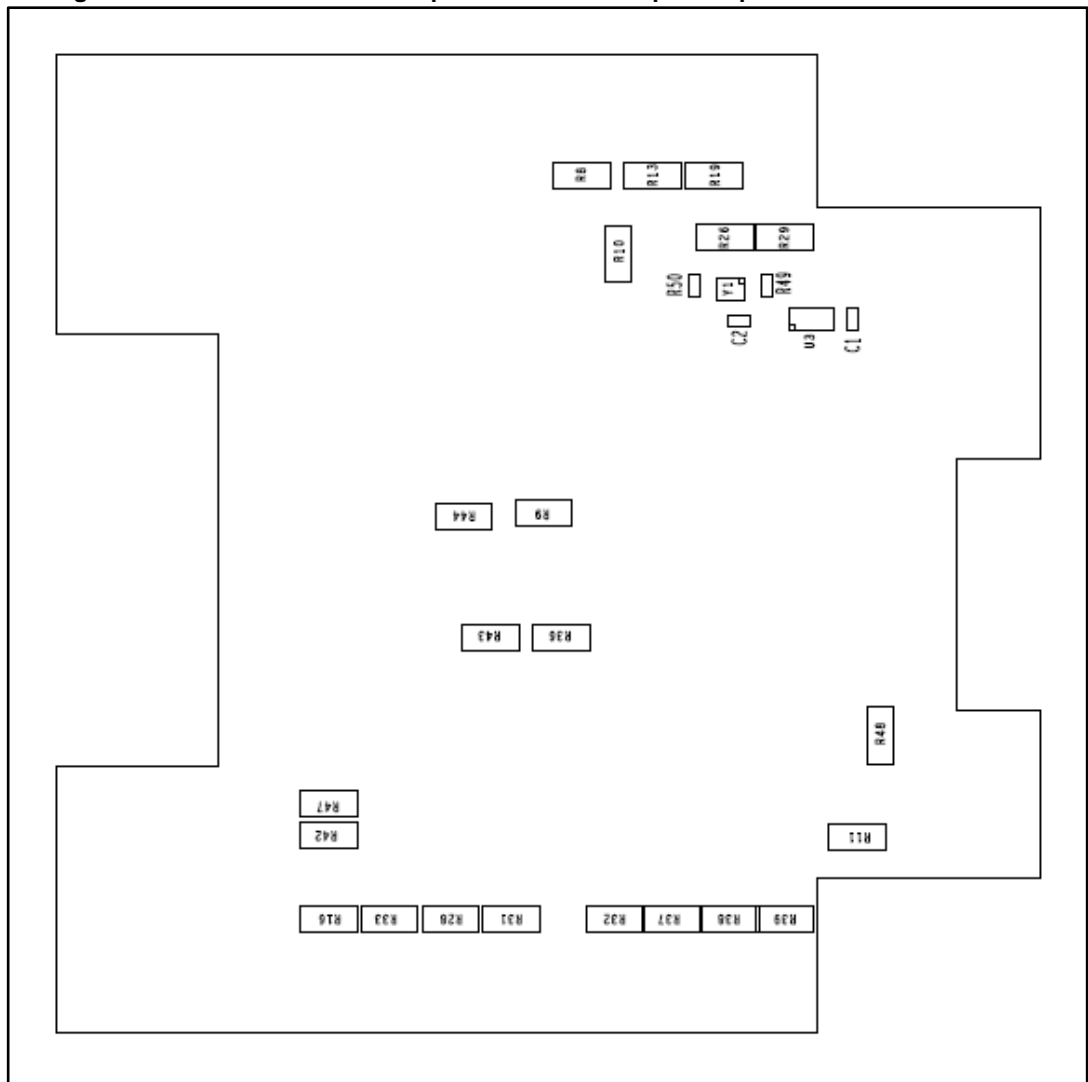

Figure 7: X-NUCLEO-IDW04A1 expansion board component placement details: bottom



3 Component description

This section describes the devices included in the X-NUCLEO-IDW04A1 expansion board.

3.1 SPWF04SA module

The SPWF04SA module is FCC (FCC ID: S9NSPWFS04), IC (IC: 8976C-SPWFS04) and CE certified.

It embeds a low power Wi-Fi b/g/n transceiver SoC, which is a highly integrated Wi-Fi system dedicated to the WLAN management and compliant with Wi-Fi network specifications. It interfaces with the STM32 Nucleo boards via UART or SPI and some GPIO pins.

The SPWF04SA module also integrates an SMD antenna and has an embedded 38.4 MHz oscillator for the embedded Wi-Fi radio.

Table 11: SPWF04SA module details

Feature	Description
Sales type	SPWF04SA
Package	SMD 35 pin
Operating voltage	Typ. 3.3 V

3.2 User push-buttons and LEDs

The X-NUCLEO-IDW04A1 expansion board has two push-buttons and four LEDs to control certain I/O signals and transmit SPWF04SA module status information.

The associated hardware and firmware functions are shown in the following table.

Table 12: Push-buttons and LED functions

Feature	Description
RESET	Push the SW1 push-button on the board
WPS	Push the SW2 push-button on the board
3.3 V board power supply on	LED 1 (green)
HEARTBEAT (GPIO10)	LED 2 (blue)
CONSOLE (GPIO14)	LED 3 (red)
STATUS (GPIO13)	LED 4 (yellow)

3.3 User interface configuration

To properly interface the X-NUCLEO-IDW04A1 expansion board according to the selected user mode (UART or SPI), you have to configure jumpers JP6, JP7, JP8 and JP9 as specified in [Table 13: "X-NUCLEO-IDW04A1 board user mode configuration settings"](#).



The X-NUCLEO-IDW04A1 board default configuration is VCOM UART.

Table 13: X-NUCLEO-IDW04A1 board user mode configuration settings

User mode	JP6	JP7	JP8	JP9
No external host	Remove	Remove	Remove	Remove
VCOM UART	1-2	1-2	1-2	1-2
VCOM SPI	2-3	2-3	2-3	2-3

4 Radio certification

4.1 Formal notices required by the U.S. federal communications commission (FCC)

Any changes or modifications to this equipment not expressly approved by STMicroelectronics may cause harmful interference and void the user's authority to operate this equipment. This device complies with Part 15 of the FCC Rules. Operation is subject to the following two conditions:

1. this device may not cause harmful interference
2. this device must accept any interference received, including any interference that may cause undesired operation.

This device uses, generates and radiates radio frequency energy. The radio frequency energy produced by this device is well below the maximum exposure limit established by the federal communications commission (FCC). The X-NUCLEO-IDW04A1 contains the FCC certified SPWF04SA module (FCC ID: S9NSPWFS04).

4.2 Formal notices required by industry Canada (IC)

English:

This device complies with Industry Canada license-exempt RSS standard(s). Operation is subject to the following two conditions:

1. this device may not cause interference
2. this device must accept any interference, including interference that may cause undesired operation of the device.

French:

Le présent appareil est conforme aux CNR d'Industrie Canada applicables aux appareils radio exempts de licence. L'exploitation est autorisée aux deux conditions suivantes: (1)

1. l'appareil ne doit pas produire de brouillage
2. l'utilisateur de l'appareil doit accepter tout brouillage radioélectrique subi, même si le brouillage est susceptible d'en compromettre le fonctionnement.

The X-NUCLEO-IDW04A1 contains the IC certified SPWF04SA module (IC: 8976C-SPWFS04)

4.3 Formal notices required by the ETSI (CE)

This module complies with the following European EMI/EMC and safety directives and standards:

- ETSI EN 300 328 V1.9.1:2015
- EN 301 489-1 V1.9.2:2011 + EN 301 489-17 V2.2.1:2012 + EN 301 489-1 V1.8.1:2008
- EN 60950-1:2006 + A11:2009 + A1:2010 + A12:2011 + A2:2013
- EN 62479:2010

5 Bill of materials

Table 14: X-NUCLEO-IDW04A1 bill of materials

Item	Q. ty	Ref.	Part/Value	Description	Manufacturer	Order code
1	11	C1, C2, C3, C6, C7, C8, C9, C11, C12, C40, C41	100 nF,16 V, 0603, X7R	Capacitor	MURATA	GRM188R71C104KA01D
2		C39	0603	NOT MOUNTED		
3	1	CN8		Arduino R3 connector	4UCON	18688 or 18689 or 20518
4	2	CN6, CN9		Arduino R3 connector	4UCON	18688 or 18689 or 20518
5	1	CN5		Arduino R3 connector	4UCON	18688 or 18689 or 20518
6		CN7,CN10			4UCON	
7	1	J1		8 pin socket connector	STELVIO KONTEK	6778268508410-R
8	2	J2		22 pin connector		
9	1	J3		6 pin connector		
10	7	JP1, JP2, JP5, JP10, JP11, JP12, JP13		2 pin jumpers		
11	6	JP3, JP4, JP6, JP7, JP8, JP9		3 pin jumpers		
12	1	LED1	0603	GREEN DIODE LED		
13	1	LED2	0603	BLUE DIODE LED		
14	1	LED3	0603	RED DIODE LED		
15	1	LED4	0603	YELLOW DIODE LED		
16	1	R3	0 Ω , 0603	Resistor		
17	1	R15	100 Ω \pm 5%,0603	Resistor		
18	3	R18, R22, R23	270 Ω \pm 5%, 0603	Resistor		

Item	Q. ty	Ref.	Part/Value	Description	Manufacturer	Order code
19	1	R5	470 Ω \pm 5%, 0603	Resistor		
20	2	R1, R45	4.7 K Ω \pm 5%,0603	Resistor		
21	4	R2, R4, R6, R24	10 K Ω \pm 5%,0603	Resistor		
22	2	R46, R49	47 K Ω \pm 5%,0603	Resistor		
23	1	R14	220 K Ω \pm 5%, 0603	Resistor		
24		R7, R25, R27, R50		NOT MOUNTED		
25	6	R16, R19, R26, R28, R31, R37	0 Ω , 0805	Resistor		
26		R8, R9, R10, R11, R13, R29, R32, R33, R36, R38, R39, R42, R43, R44, R47, R48	0805	NOT MOUNTED		
27	2	SW1,SW2	SMD	Switch push buttons	ITT	KSR221J
					IN SUNG METAL CO	IT-1210-S
					ALPS	SKQYAB (G4822969M)
28		Y1		16 MHz oscillator -NOT MOUNTED		
29		U3		32 MHz oscillator -NOT MOUNTED		
30		U11	USON8	NOT MOUNTED (I.C. Serial Flash 8Mbit 2.7-3.6 V p/n MX25L8006EZ UI-12G)	MACRONIX	MX25L8006EZUI-12G
31	1	U12		Micro SD Socket p/n 112A-TAAR- R03	ATTEND	112A-TAAR-R03
32	3	TP3, TP4, TP5		PIN 1 pole		

Bill of materials**UM2183**

Item	Q. ty	Ref.	Part/Value	Description	Manufacturer	Order code
33	1	WF1		SPWF04SA Wi-Fi Module	ST	MT4162LC6F

6 Schematic diagrams

Figure 8: X-NUCLEO-IDW04A1 circuit schematic

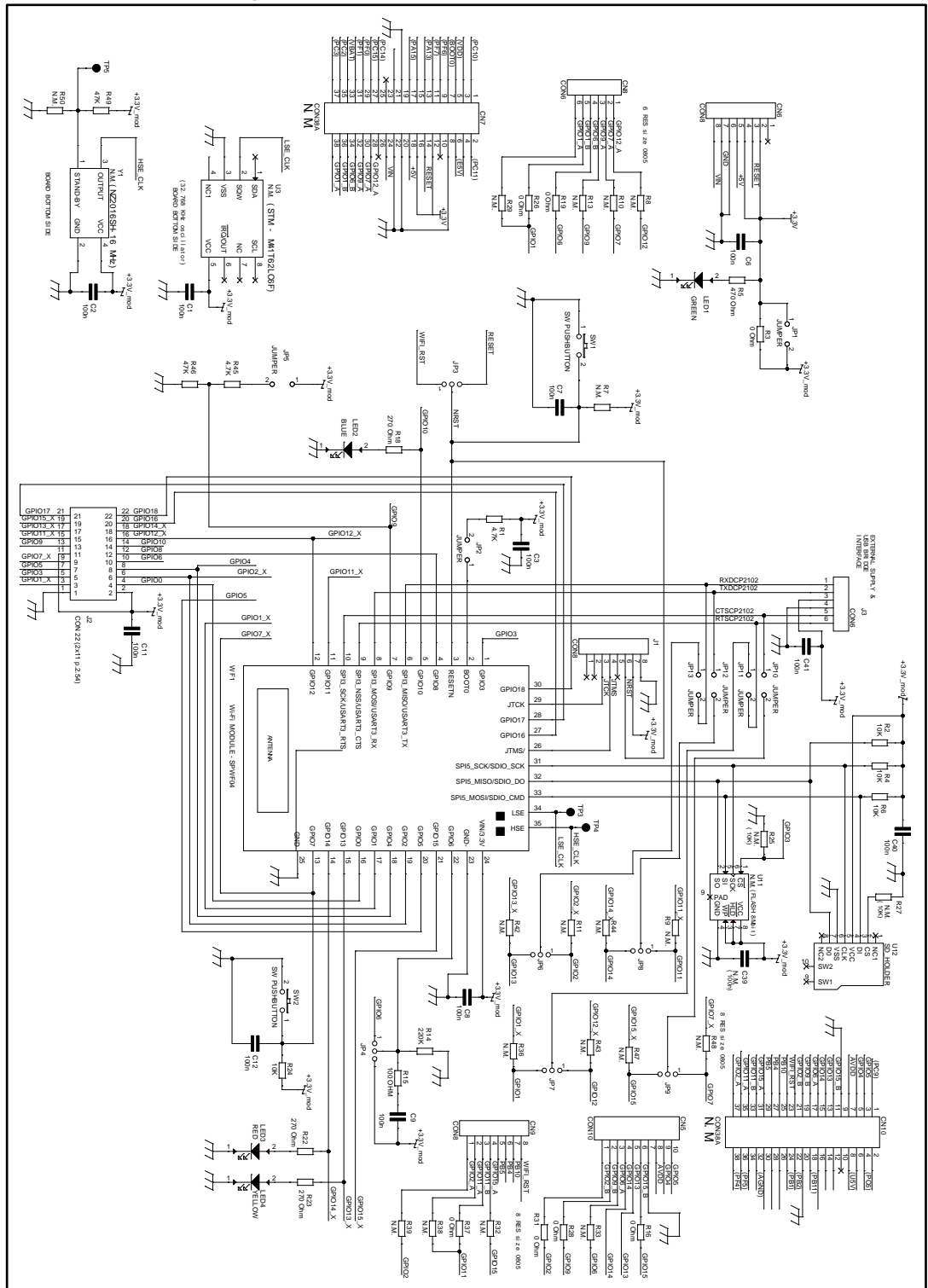

7 Revision history

Table 15: Document revision history

Date	Revision	Changes
10-Mar-2017	1	Initial release.

IMPORTANT NOTICE – PLEASE READ CAREFULLY

STMicroelectronics NV and its subsidiaries ("ST") reserve the right to make changes, corrections, enhancements, modifications, and improvements to ST products and/or to this document at any time without notice. Purchasers should obtain the latest relevant information on ST products before placing orders. ST products are sold pursuant to ST's terms and conditions of sale in place at the time of order acknowledgement.

Purchasers are solely responsible for the choice, selection, and use of ST products and ST assumes no liability for application assistance or the design of Purchasers' products.

No license, express or implied, to any intellectual property right is granted by ST herein.

Resale of ST products with provisions different from the information set forth herein shall void any warranty granted by ST for such product.

ST and the ST logo are trademarks of ST. All other product or service names are the property of their respective owners.

Information in this document supersedes and replaces information previously supplied in any prior versions of this document.

© 2017 STMicroelectronics – All rights reserved